

# Submersible Sewage Pumps with Channel Impeller

*Redesigned BZ-series pumps with wide solids passages of over 3 inches and high pumping efficiency*

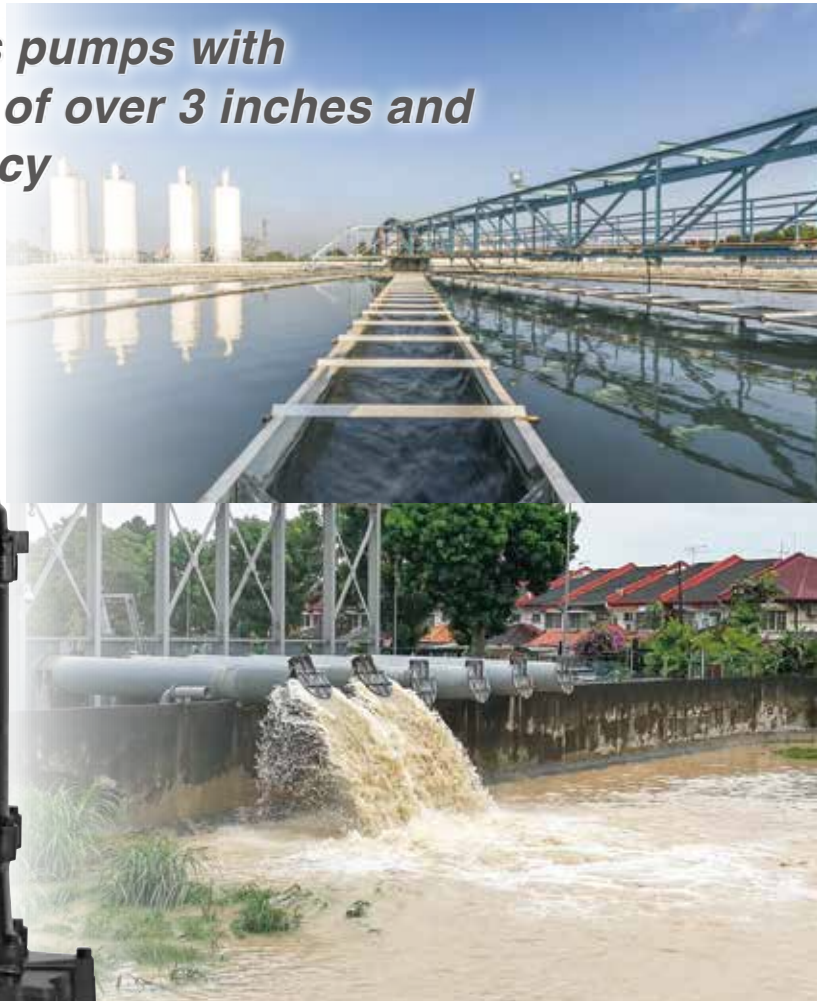

## **BZ** SERIES

are heavy-duty, submersible sewage and wastewater pumps with a shrouded two-channel impeller. They are innovatively designed with wide passages of over 3 inches (76.2 mm) in diameter to minimize trouble due to clogged solids. Moreover, they raise the already high pump efficiency standard of predecessor sewage and wastewater pumps of the Tsurumi brand with even better energy efficiency.

The BZ-series pumps come packed with a number of original technologies developed and honed over years of service including an anti-wicking cable, motor protector, dual inside mechanical seals with silicon carbide faces and Oil Lifter. Moreover, the pumps can be used with Tsurumi's guide rail fitting device that facilitates installation and maintenance.

Highly reliable and durable, Tsurumi's BZ-series pumps are designed and built for sound quality and continuous duty that can help you keep your systems running stably and greatly reduce your maintenance costs.

## **Applications**

- Sewerage and raw wastewater treatment plants, factory wastewater drainage
- Sewerage bypass systems
- Agricultural and industrial water intake
- Rain water drainage, flood water removal
- Irrigation

# Model Selection

Discharge Bore mm	Model		Motor Output kW	Phase	Speed (S.S.) 50/60Hz min <sup>-1</sup>	Starting Method	Solids Passage 50/60Hz mm	Cable Length m
	Free Standing	Guide Rail Fitting						
200	200BZ622	TO200BZ622	22	Three	1000 / 1200	Star-Delta	76.2	10
	200BZ430	TO200BZ430	30	Three	1500 / 1800	Star-Delta	76.2	10
	200BZ437	TO200BZ437	37	Three	1500 / 1800	Star-Delta	76.2	10
	200BZ445	TO200BZ445	45	Three	1500 / 1800	Star-Delta	76.2	10
	200BZ455	TO200BZ455	55	Three	1500 / 1800	Star-Delta	76.2	10
	200BZ475	TO200BZ475	75	Three	1500 / 1800	Star-Delta	76.2	10
250	250BZ622	TO250BZ622	22	Three	1000 / 1200	Star-Delta	90 / 80	10
	250BZ430	TO250BZ430	30	Three	1500 / 1800	Star-Delta	80 / 79	10
	250BZ437	TO250BZ437	37	Three	1500 / 1800	Star-Delta	80 / 79	10
	250BZ445	TO250BZ445	45	Three	1500 / 1800	Star-Delta	80 / 79	10
	250BZ455	TO250BZ455	55	Three	1500 / 1800	Star-Delta	90 / 80	10
	250BZ475	TO250BZ475	75	Three	1500 / 1800	Star-Delta	90 / 80	10
250 -High Head-	250BZ622H	TO250BZ622H	22	Three	1000 / 1200	Star-Delta	76.2	10
	250BZ430H	TO250BZ430H	30	Three	1500 / 1800	Star-Delta	76.2	10
	250BZ437H	TO250BZ437H	37	Three	1500 / 1800	Star-Delta	76.2	10
	250BZ445H	TO250BZ445H	45	Three	1500 / 1800	Star-Delta	76.2	10
	250BZ455H	TO250BZ455H	55	Three	1500 / 1800	Star-Delta	76.2	10
	250BZ475H	TO250BZ475H	75	Three	1500 / 1800	Star-Delta	76.2	10
300	300BZ622	TO300BZ622	22	Three	1000 / 1200	Star-Delta	90	10
	300BZ630	TO300BZ630	30	Three	1000 / 1200	Star-Delta	90	10
	300BZ637	TO300BZ637	37	Three	1000 / 1200	Star-Delta	90	10
	300BZ645	TO300BZ645	45	Three	1000 / 1200	Star-Delta	90	10
	300BZ655	TO300BZ655	55	Three	1000 / 1200	Star-Delta	90	10
	300BZ475	TO300BZ475	75	Three	1500 / 1800	Star-Delta	90	10
300 -High Head-	300BZ622H	TO300BZ622H	22	Three	1000 / 1200	Star-Delta	90 / 80	10
	300BZ430H	TO300BZ430H	30	Three	1500 / 1800	Star-Delta	80 / 79	10
	300BZ437H	TO300BZ437H	37	Three	1500 / 1800	Star-Delta	80 / 79	10
	300BZ445H	TO300BZ445H	45	Three	1500 / 1800	Star-Delta	80 / 79	10
	300BZ455H	TO300BZ455H	55	Three	1500 / 1800	Star-Delta	90 / 80	10
	300BZ475H	TO300BZ475H	75	Three	1500 / 1800	Star-Delta	90 / 80	10
350 -High Head-	350BZ622H	TO350BZ622H	22	Three	1000 / 1200	Star-Delta	90	10
	350BZ630H	TO350BZ630H	30	Three	1000 / 1200	Star-Delta	90	10
	350BZ637H	TO350BZ637H	37	Three	1000 / 1200	Star-Delta	90	10
	350BZ645H	TO350BZ645H	45	Three	1000 / 1200	Star-Delta	90	10
	350BZ655H	TO350BZ655H	55	Three	1000 / 1200	Star-Delta	90	10
	350BZ475H	TO350BZ475H	75	Three	1500 / 1800	Star-Delta	90	10

# Features

## 1 Anti-wicking Cable Entry

Prevents water incursion due to capillary action should the cable sheath be damaged or the end of cable submerged. Also prevents moist air from infiltrating the motor housing and condensation from forming inside the housing due to temperature differences between the housing and outside air.

## 2 Miniature Thermal Protectors

React to excessive heat caused by dry-running. The bimetal strip opens to cause the control panel to shut the power supply.

## 3 Water Jacket

(55kW and above of 200 & 250mm bore, and 45kW and above of 300 & 350mm bore)

The pump is equipped with a water jacket, around the motor frame. A portion of the pumped liquid is allowed to flow into the water jacket to cool the motor. This design feature permits the unit to operate at low water levels for extended periods of time.

## 4 Dual Inside Mechanical Seals with Silicon Carbide Faces

Eliminates problems like spring failure and ensures a long service life. Isolated in the oil chamber where a clean, non-corrosive and abrasion-free lubricating environment is maintained. The silicon carbide provides 5 times higher corrosion, wear and heat resistance than the tungsten carbide.

## 5 Oil Lifter

Provides lubrication and cooling of the seal faces down to 1/3 of normal oil level, thus maintaining a stable shaft sealing effect and prolonging seal life longer. The Oil Lifter is Tsurumi original design.

## 7 Seal Pressure Relief Port

Protect the mechanical seal from pump pressure. It also protects the seal face by discharging wear particles.

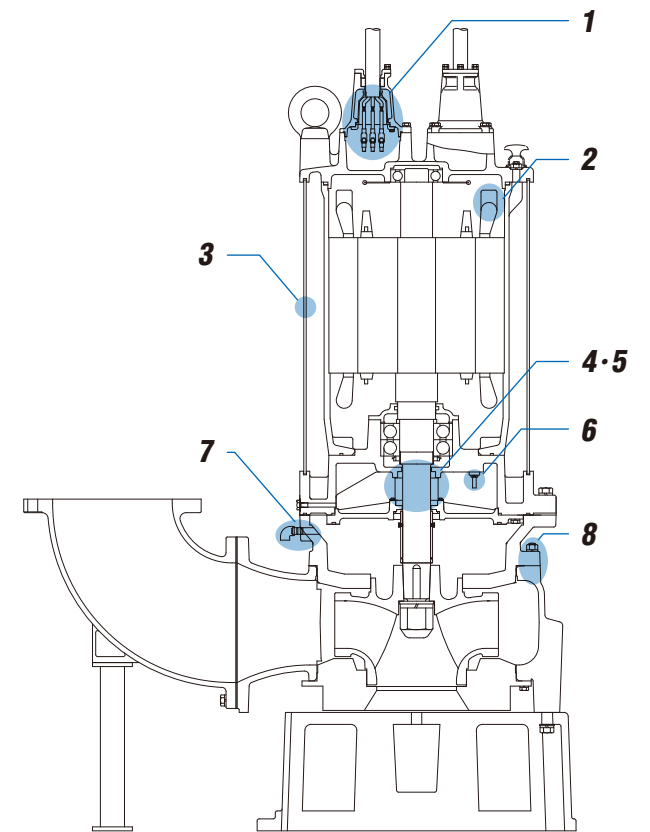

## 6 Leakage Sensor

Detects flooding into the oil chamber that may occur in a worst case scenario. When flooding is detected, signals are sent to operate the indicator lamps through the external control panel.

## 8 Back Pull-out Design

Enables the motor to be separated from the pump unit with the impeller attached, by removing the bolts between the oil casing and the pump casing. This design facilitates maintenance and inspection of the principal parts of the pump.

# Model Number Designation

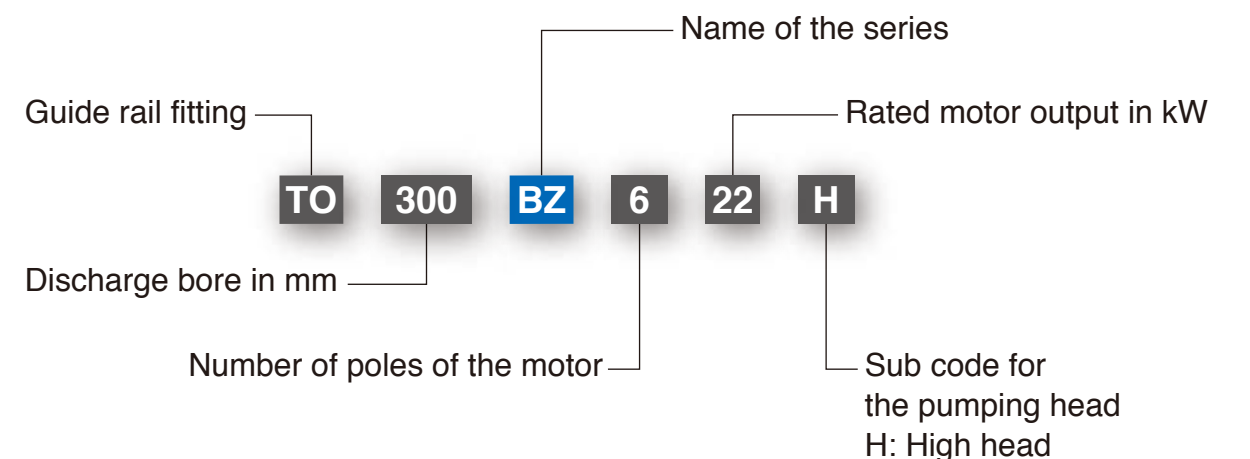

# Performance Curves

< 200mm >

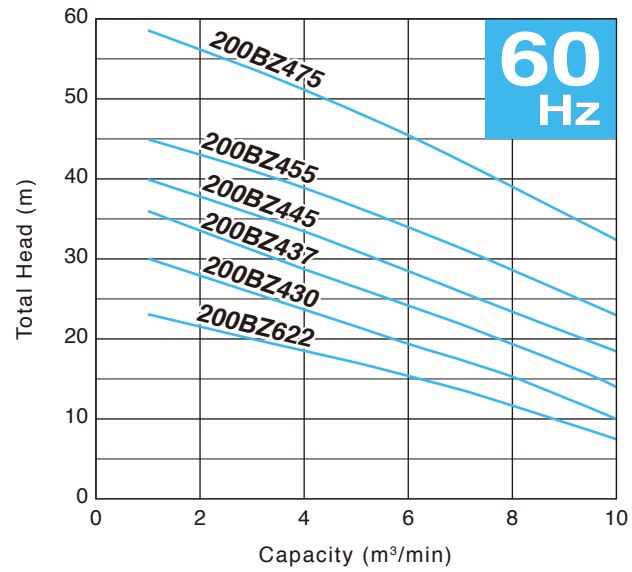
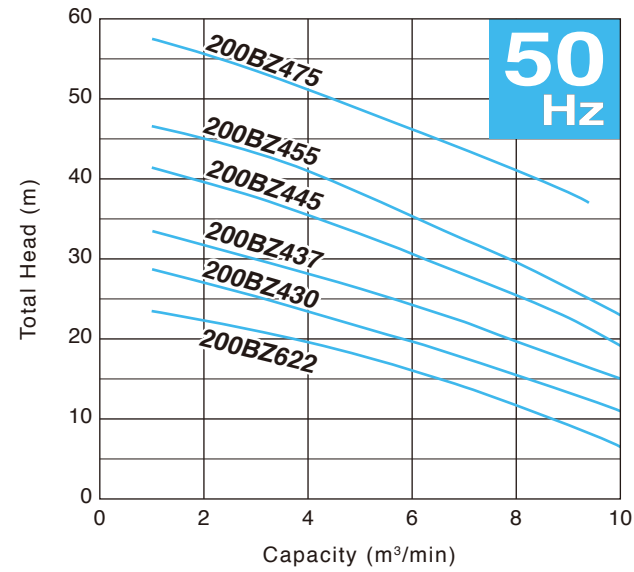

< 300mm >

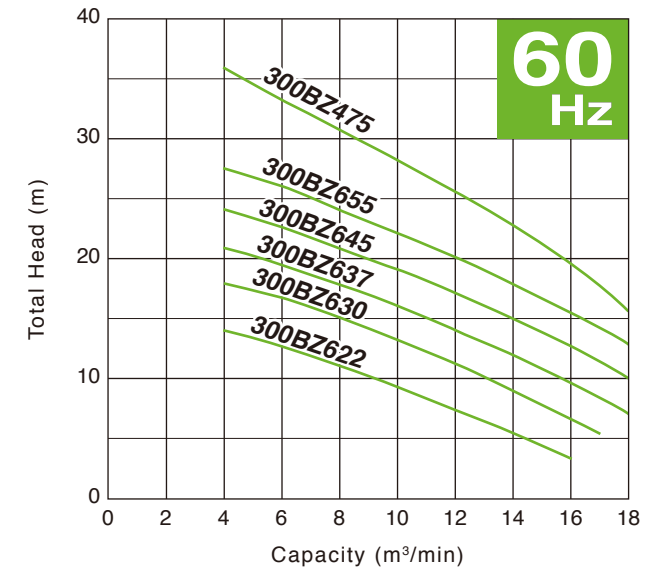
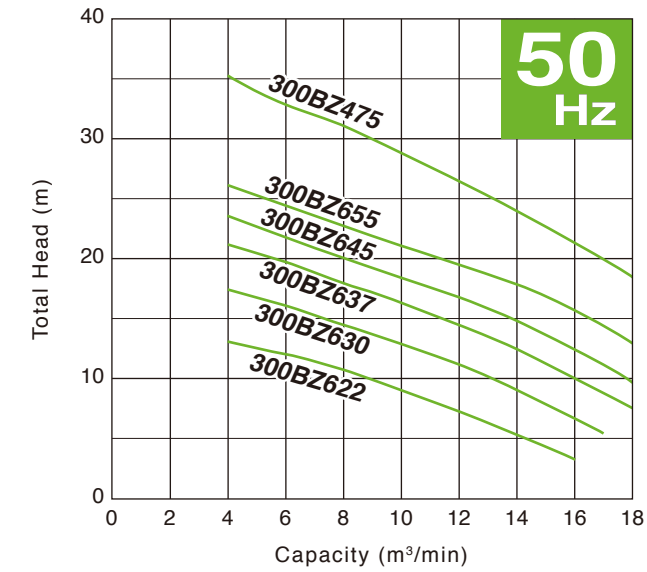

< 250mm >

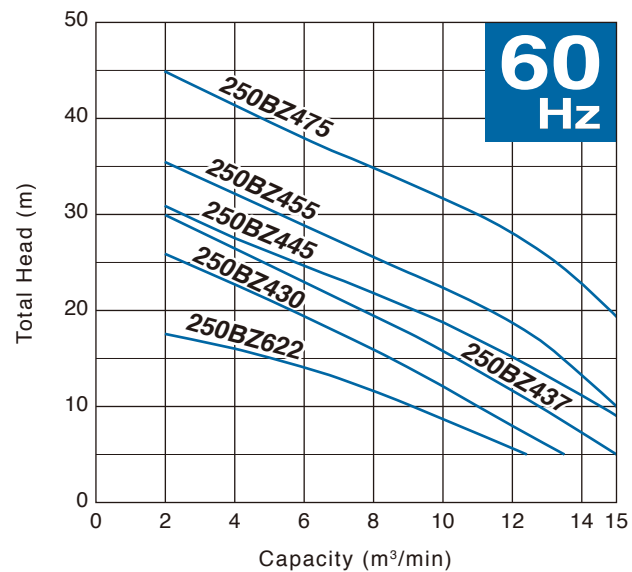
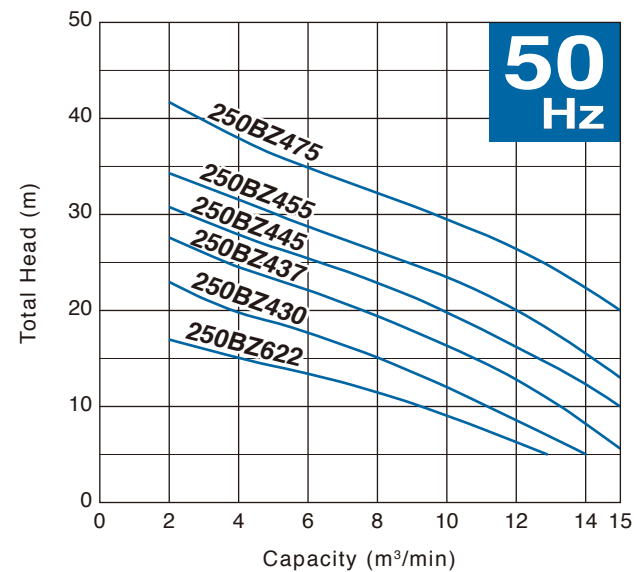

< 300mm -High Head- >

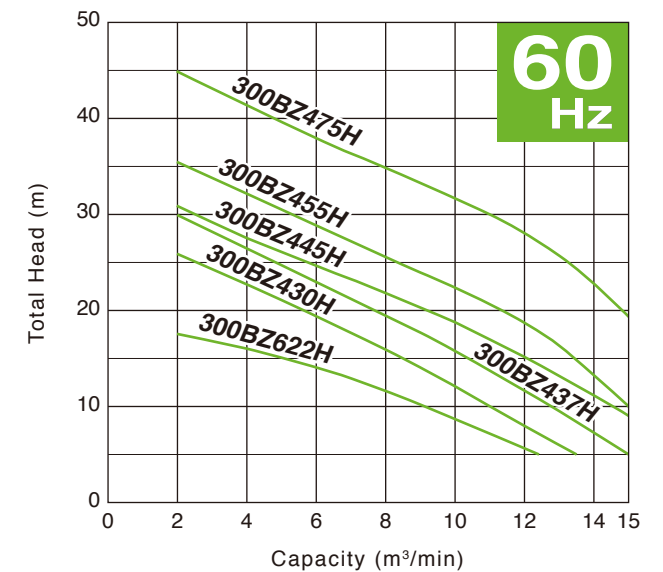
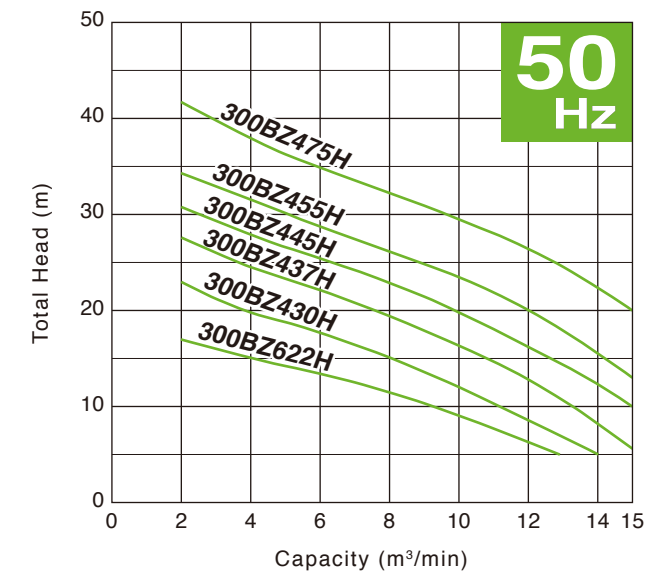

< 250mm -High Head- >

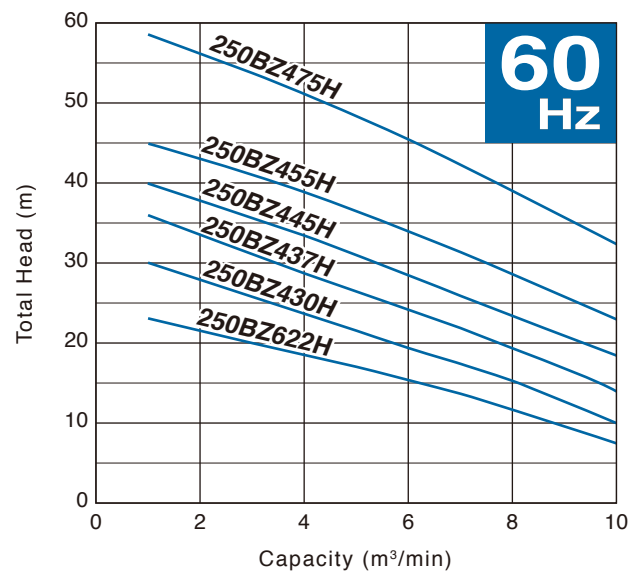
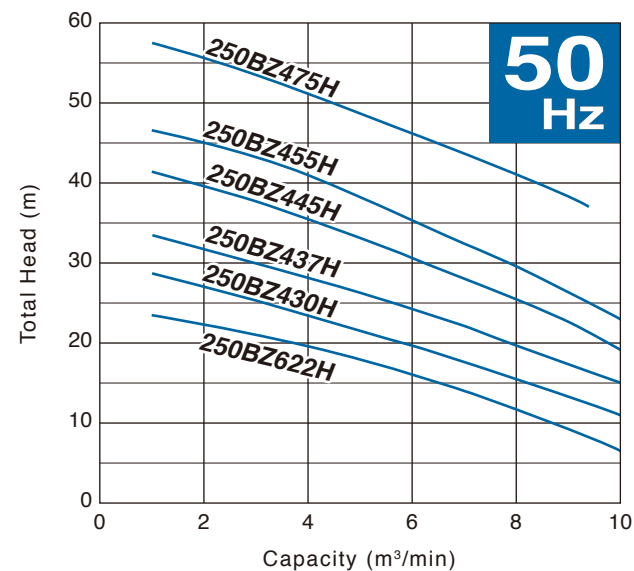

< 350mm -High Head- >

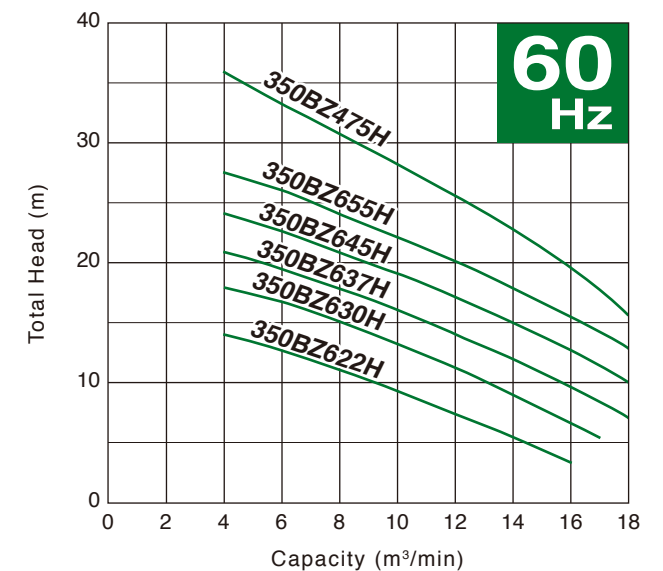
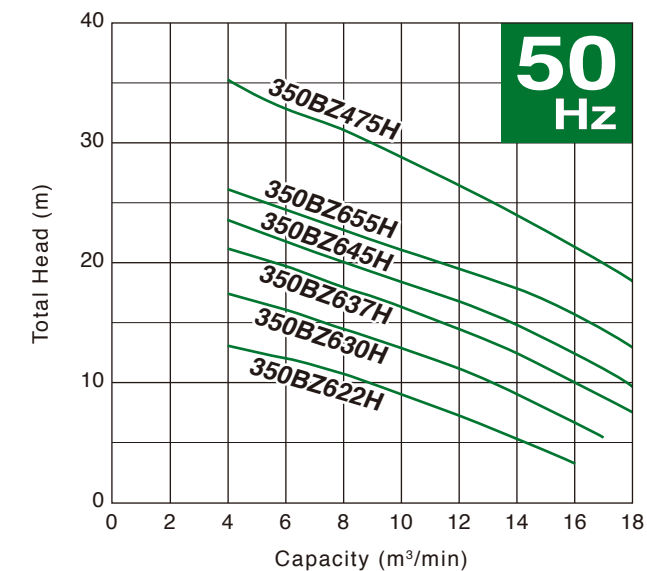



Product images and specifications may differ from actual products due to improvements. The OO series and model OO are indicated with our series/model codes in this catalog.

**TSURUMI  
MANUFACTURING CO., LTD.**

Your Dealer